



NIPPON HAKUYOHIN KENTEI KYOKAI  
(The Ship Equipment Inspection Society of Japan)

CERTIFICATE OF RECEPTACLE  
FOR DANGEROUS GOODS

Certificate No. 260S-t-2788

Kind and Type	Packaging of Small size Steel Jerricans (non-removable head) 3A1
Name or Title and Address of Applicant	Fujii Yohki Industries Co., Ltd. Nara Factory 1193-1, Ichinomoto-cho, Tenri-shi, Nara, Japan
Name or Title of Manufacturer	Fujii Yohki Industries Co., Ltd. Nara Factory
Manufacturer's Serial Number	.....
Remarks	<p>Marking:  3A1/Y /100/YR J/HK/FYN</p> <p>YR means the last two digits of the year during which the packaging was manufactured is to be marked on the packagings. Quantity : 50000 pieces</p> <p>Manufacture Duration of Packagings : Until 8 December 2026</p>

This is to certify that the receptacle identified above has been inspected as shown on the attached paper and that this receptacle conforms to the requirements of Part 4 and Part 6 of IMDG Code.  
This certificate is issued in accordance with the provision of Article 113, Paragraph 3 of the Regulations for the Carriage and Stowage of Dangerous Goods by Ships (Ministry of Transport Ordinance No.30 of 1957) as amended.

Date 13 May 2026

  
Surveyor SHIOTA Yoshihisa  
NIPPON HAKUYOHIN KENTEI KYOKAI

Note NIPPON HAKUYOHIN KENTEI KYOKAI is a designated National Competent Authority which is listed in the list of paragraph 7.9.3 of IMDG Code.

# TEST REPORT OF PACKAGING

Test Report No. 26OS-t-2788

Date of Report 13 May 2026

1. Kind of Packaging : Steel Jerricans (non-removable head)
2. Type of Packaging : 3A1
3. Name and Address of Test Facility : Fujii Yohki Industries Co., Ltd. Nara Factory  
1193-1, Ichinomoto-cho, Tenri-shi, Nara, Japan
4. Name and Address of Applicant : Fujii Yohki Industries Co., Ltd. Nara Factory  
1193-1, Ichinomoto-cho, Tenri-shi, Nara, Japan
5. Date of Test : 13 April 2026
6. Name and Address of Manufacturer : Fujii Yohki Industries Co., Ltd. Nara Factory  
1193-1, Ichinomoto-cho, Tenri-shi, Nara, Japan
7. Description of the Packaging Design Type : Refer to attached drawings.
8. Maximum Capacity : 18.8 litres
9. Characteristic of Test Contents : Water
10. Test Descriptions and Results :

Test Items	Test Standard		Test Results
General Inspection:			Good
Drop Test:IMDG Code Chapter 6.1.5.3	Drop Height	1.2 m	Pass
Leak Test:IMDG Code Chapter 6.1.5.4	Test Pressure	20 kPa	Pass
Pressure Test:IMDG Code Chapter 6.1.5.5	Test Pressure	100 kPa	Pass
Stacking Test:IMDG Code Chapter 6.1.5.6	Stacking Load	319 kg	Pass

Surveyor SHIOTA Yoshinisa

NIPPON HAKUYOHIN KENTEI KYOKAI

The packaging prepared as for transport was tested in accordance with the appropriate provisions of the IMDG Code. The use of other packaging methods or components may render it invalid.

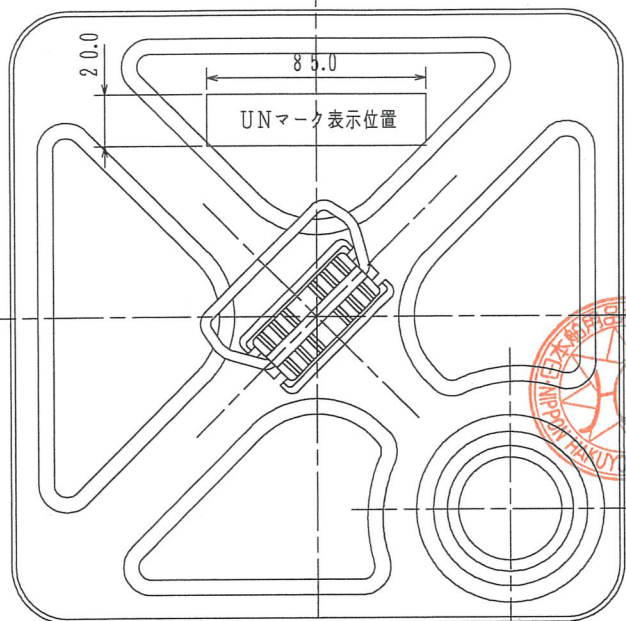

型式	3A1	
寸法 (mm)	238.0±1.0×238.0±1.0×349.0±1.0	
風袋重量 (キャップ付き) g	1210.0±60.0	
材質	天板	ティンフリースチール (JIS G 3315) 板厚 0.36mm (内面コーティング含む)
	底板	ふりき (JIS G 3303) ティンフリースチール (JIS G 3315) 板厚 0.36mm
	胴板	ティンフリースチール (JIS G 3315) 板厚 0.32mm
天、地接合方法	二重巻締め	
巻締め充填材メーカー名 及び品名	東亜合成 (株) キャニーボンド Lタイプ	
胴部接合方法	溶接	



44.0±1.0

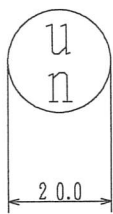

3A1/Y/100/YR  
J/HK/FYN

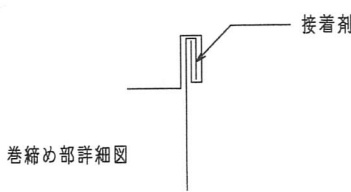
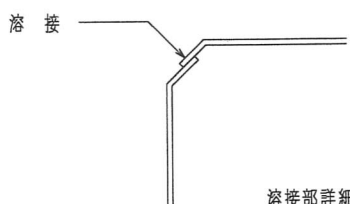
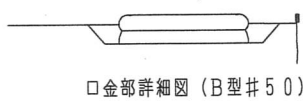
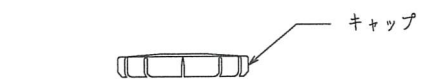
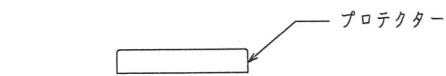
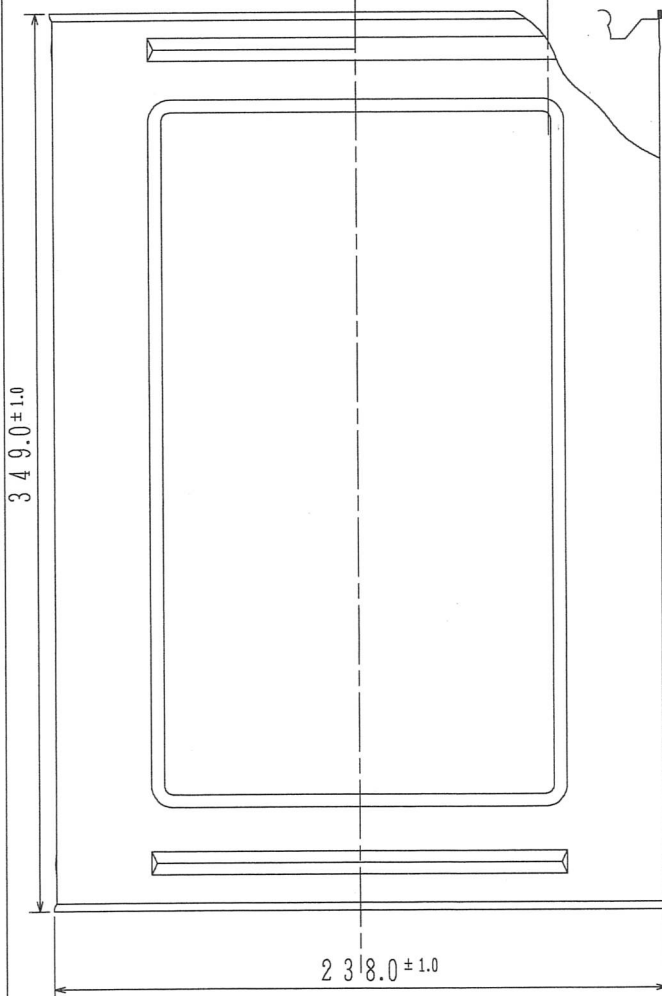

品名	18L#50UN	尺度
出図	2026. 4.15	
藤井容器工業株式会社		図番

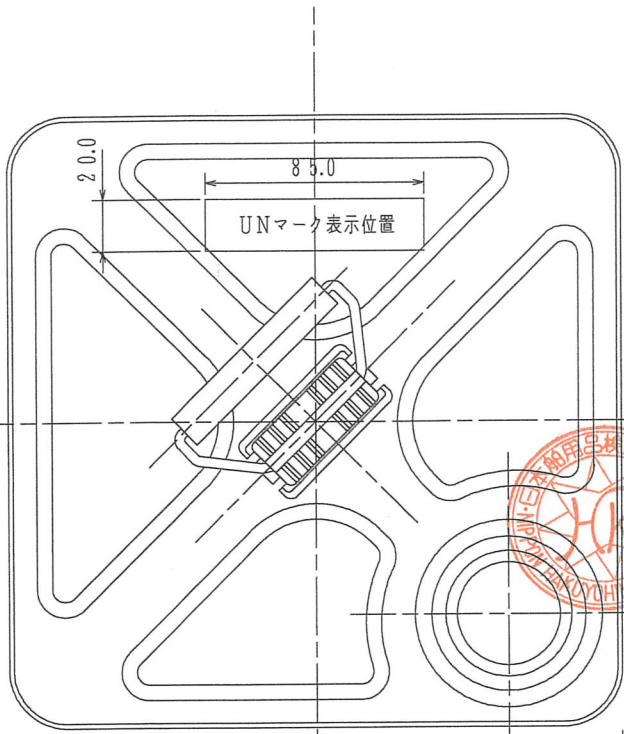

型式	3A1	
寸法 (mm)	238.0±1.0×238.0±1.0×349.0±1.0	
風袋重量 (キャップ付き) g	1210.0±60.0	
材質	天板	ティンフリースチール (JIS G 3315) 板厚 0.36mm (内面コーティング含む)
	底板	ふりき (JIS G 3303) ティンフリースチール (JIS G 3315) 板厚 0.36mm
	胴板	ティンフリースチール (JIS G 3315) 板厚 0.32mm
天、地接合方法	二重巻締め	
巻締め充填材メーカー名 及び品名	東亜合成 (株) キャーボンド Lタイプ	
胴部接合方法	溶接	

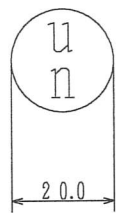
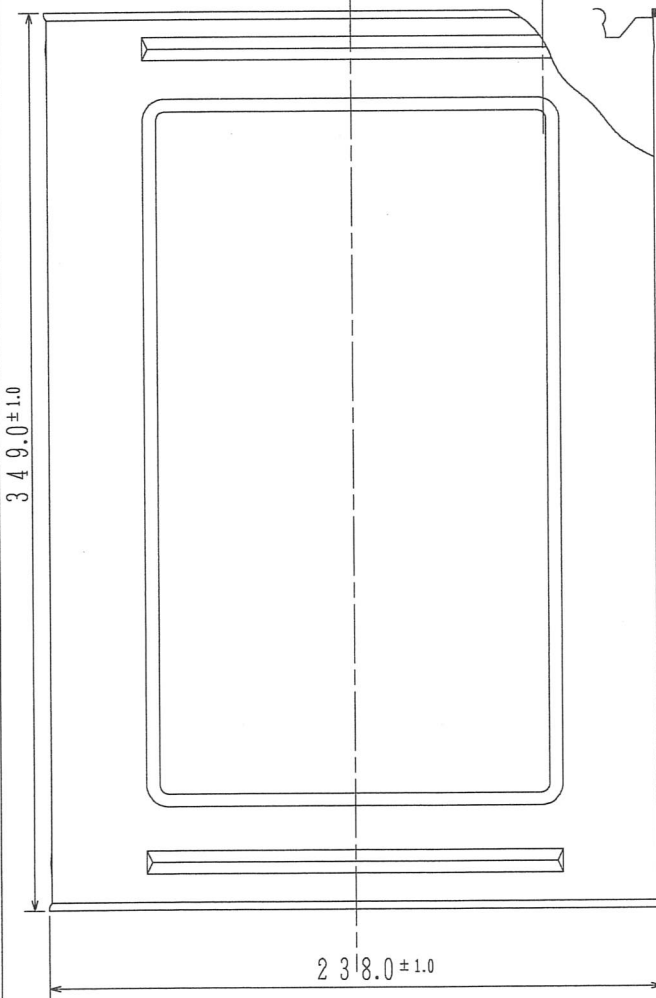

3A1/Y/100/YR  
J/HK/FYN

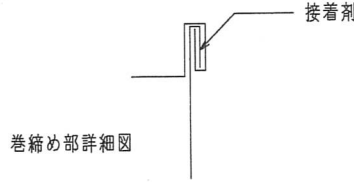
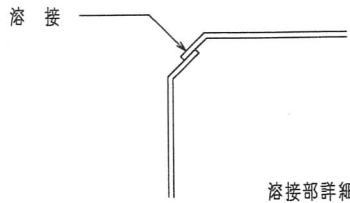
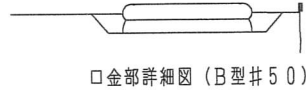
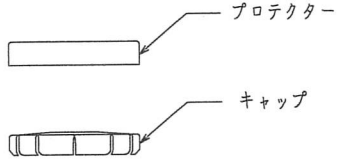

品名	18L#50UN	尺度
出図	2026. 4.15	
藤井容器工業株式会社		図番