



NIPPON HAKUYOHIN KENTEI KYOKAI
(The Ship Equipment Inspection Society of Japan)



CERTIFICATE OF RECEPACLE
FOR DANGEROUS GOODS

Certificate No. 23OS-t-7685

Kind and Type	Packaging of Small size Steel Jerricans (non-removable head) KP4L
Name or Title and Address of Applicant	Fujii Yohki Industries Co., Ltd. 6-19, Higashi-nakahama, 8-chome, Johtoh-ku, Osaka, Japan
Name or Title of Manufacturer	Fujii Yohki Industries Co., Ltd. Nara Factory
Manufacturer's Serial Number
Remarks	<p>Marking:  3A1/Y 1.6/100/YR J/HK/FYN</p> <p>YR means the last two digits of the year during which the packaging was manufactured is to be marked on the packagings. Quantity : 50000 pieces</p> <p>Manufacture Duration of Packagings : Until 31 May 2024</p>

This is to certify that the receptacle identified above has been inspected as shown on the attached paper and that this receptacle conforms to the requirements of Part 4 and Part 6 of IMDG Code. This certificate is issued in accordance with the provision of Article 113, Paragraph 3 of the Regulations for the Carriage and Stowage of Dangerous Goods by Ships (Ministry of Transport Ordinance No.30 of 1957) as amended.

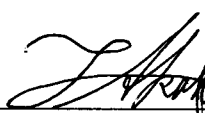
Date 25 December 2023

Surveyor AKAHORI Tadashi
NIPPON HAKUYOHIN KENTEI KYOKAI 

Note NIPPON HAKUYOHIN KENTEI KYOKAI is a designated National Competent Authority which is listed in the list of paragraph 7.9.3 of IMDG Code.



TEST REPORT OF PACKAGING

Test Report No. 23OS-t-7685

Date of Report 25 December 2023

1. Kind of Packaging : Steel Jerricans (non-removable head)
2. Type of Packaging : KP4L
3. Name and Address of Test Facility : Fujii Yohki Industries Co., Ltd. Nara Factory
1149-8, Kitatawara-cho, ikoma, Nara, Japan
4. Name and Address of Applicant : Fujii Yohki Industries Co., Ltd.
6-19, Higashi-nakahama, 8-chome, Johto-ku, Osaka, Japan
5. Date of Test : 19 December 2023
6. Name and Address of Manufacturer : Fujii Yohki Industries Co., Ltd. Nara Factory
1149-8, Kitatawara-cho, ikoma, Nara, Japan
7. Description of the Packaging Design Type : Refer to attached drawings.
8. Maximum Capacity : 4.4 litres
9. Characteristic of Test Contents : Water
10. Test Descriptions and Results :

Test Items	Test Standard		Test Results
General Inspection:			Good
Drop Test:IMDG Code Chapter 6.1.5.3	Drop Height	1.6 m	Pass
Leak Test:IMDG Code Chapter 6.1.5.4	Test Pressure	20 kPa	Pass
Pressure Test:IMDG Code Chapter 6.1.5.5	Test Pressure	100 kPa	Pass
Stacking Test:IMDG Code Chapter 6.1.5.6	Stacking Load	85 kg	Pass

Surveyor AKAHO Tadashi

NIPPON HAKUYOHIN KENTEN KAI

The packaging prepared as for transport was tested in accordance with the appropriate provisions of the IMDG Code. The use of other packaging methods or components may render it invalid.

型式	3A1 (KP4L)
寸法 (mm) (±1.0)	103.0×168.0×27.0
風量重量 (キヤップ付) g	390.0±20.0
材質	天板 ふりき (JIS G 3303) 板厚 0.28mm
	底板 ふりき (JIS G 3303) 板厚 0.28mm
	胴板 ふりき (JIS G 3303) 板厚 0.25mm
天、底接合方法	二重巻締め
巻締め充填剤メーカー名	福岡パッキング (株)
及び品名	S365
胴部接合方法	溶接



 3A1/Y1.6

 100/YR/J

 HK/FYN

 20.0

 9.0

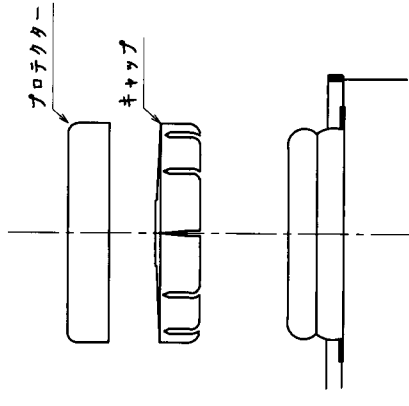
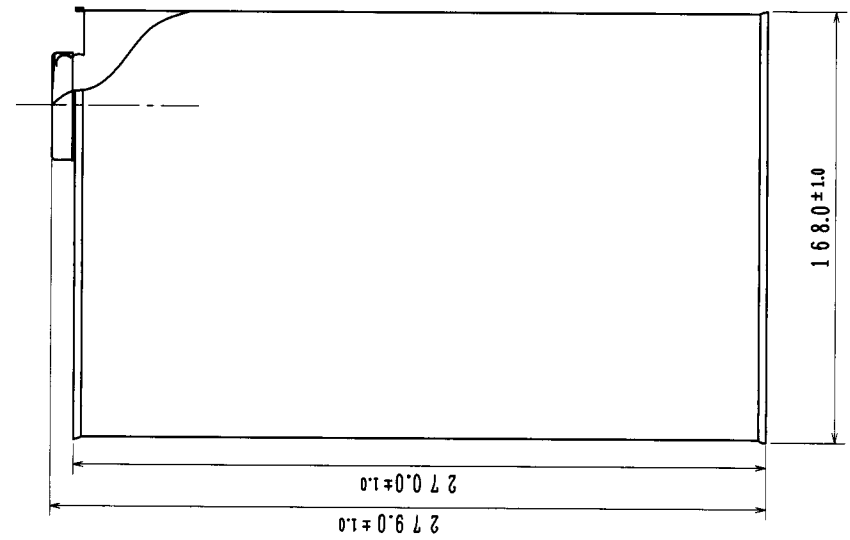
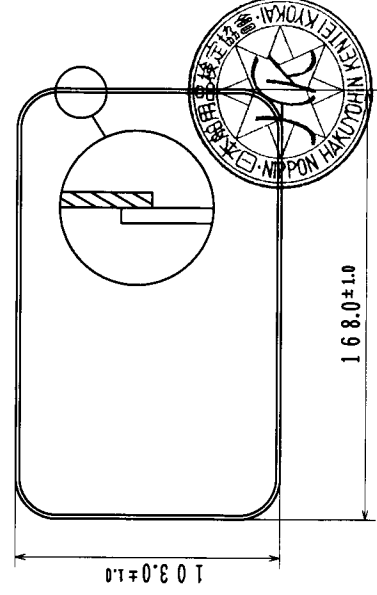
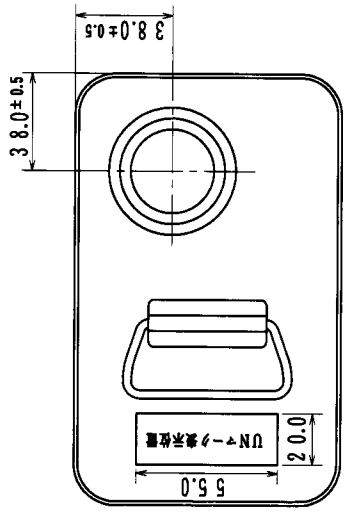

口金部詳細図 (B型 井40)

巻締め部詳細図

品名	4k角 UN缶	尺	度
出図	2023.12.21		
藤井容器工業株式会社		図番	